

**▶KING** || **ONE<sup>PRO</sup>**<sup>™</sup>

---

---

## **KOP4800 Owner's Manual**



**For use with DIRECTV<sup>®</sup> satellite programming**



## IMPORTANT!

The satellite TV market is expanding and changing. The information in this manual was accurate at the time of printing. If your KING One Pro Satellite Antenna does not operate as outlined in this manual, please call KING® at (952) 345-8147 or visit our website at [kingconnect.com](http://kingconnect.com). KING is not responsible for changes outside of its control.

## CONTENTS

INTRODUCTION .....	2-3
IMPORTANT SAFETY AND CARE INFORMATION .....	2
ABOUT SIGNAL LOSS .....	3
SECURITY .....	3
SETUP .....	4
CONTENTS .....	4
APPLY RUBBER FEET TO ANTENNA UNIT .....	4
CONNECTIONS .....	5-7
DIRECTV CONNECTIONS .....	6
DIRECTV CONNECTIONS WITH H/HR25 RECEIVER OR HIGHER .....	7
OPERATIONS .....	8-11
RECEIVER CONFIGURATION .....	8
ANTENNA CONFIGURATION .....	8-9
SCAN FOR SATELLITES .....	10-11
TROUBLESHOOTING .....	12
ACCESSORIES .....	13
LIMITED WARRANTY .....	14
FCC GUIDELINES .....	15

# INTRODUCTION

**Thank you for choosing the premium KING One Pro Portable HDTV System!**

The KING One Pro is factory programmed to work with DIRECTV. No antenna configuration is required. (The configuration process is shown on pages 8-9 for future reference.)

## IMPORTANT SAFETY AND CARE INFORMATION

1. Keep the Quick Reference Guide and Installation Guide that came with your KING One Pro in a safe place for future reference. You may also print this on-line manual and keep it for future reference as well.
2. Follow all instructions and warnings. Set up and operate the KING One Pro in accordance with the instructions.
3. To avoid risk of electric shock, unplug your receiver before connecting/disconnecting the KING One Pro in damp or wet conditions.
4. Tighten all of the coax cable connections by hand only. If you use a wrench, you may over-tighten the connections and damage your equipment.
5. Always handle the KING One Pro carefully. Do not drop the KING One Pro. Avoid excessive shock or vibration to the KING One Pro.
6. Use caution when carrying the KING One Pro. Always carry the KING One Pro by the handle.
7. Do not remove the cover of the KING One Pro without authorization. Doing so will void the limited warranty.
8. Do not stack the KING One Pro on top of or below other electronic devices as this can cause heat build-up or block the satellite signal from reaching the KING One Pro.
9. Do not operate or store near any indoor or outdoor heat source such as radiators, heat registers, stoves, barbecues, campfires, or other items that produce heat.
6. Servicing may be required if the unit has been dropped or damaged in any way or if the unit does not operate normally. Call KING Customer Service at (952) 345-8147.
10. Do not power wash the KING One Pro.
11. Do not submerge the KING One Pro or place in standing water.
12. Keep the enclosure clean from dirt, bugs, and other debris by hand washing with mild soap and water.
13. Do not coat or paint the KING One Pro with any substance.

The KING One Pro has been designed to be maintenance and trouble free. If not using the KING One Pro for long periods of time, it is recommended that you set up the system on a quarterly basis (every three months) to keep all moving parts of the KING One Pro in good working order.

## ABOUT SIGNAL LOSS

### OBSTRUCTIONS

The KING One Pro requires an unobstructed view of the southern sky for the best signal reception.

Be sure to place the KING One Pro in a location free from obstructions such as people, trees, buildings, vehicles, etc. This will allow for the strongest signal and will help prevent any interruption to your programming. Pointing the handle approximately north may speed up scan time.

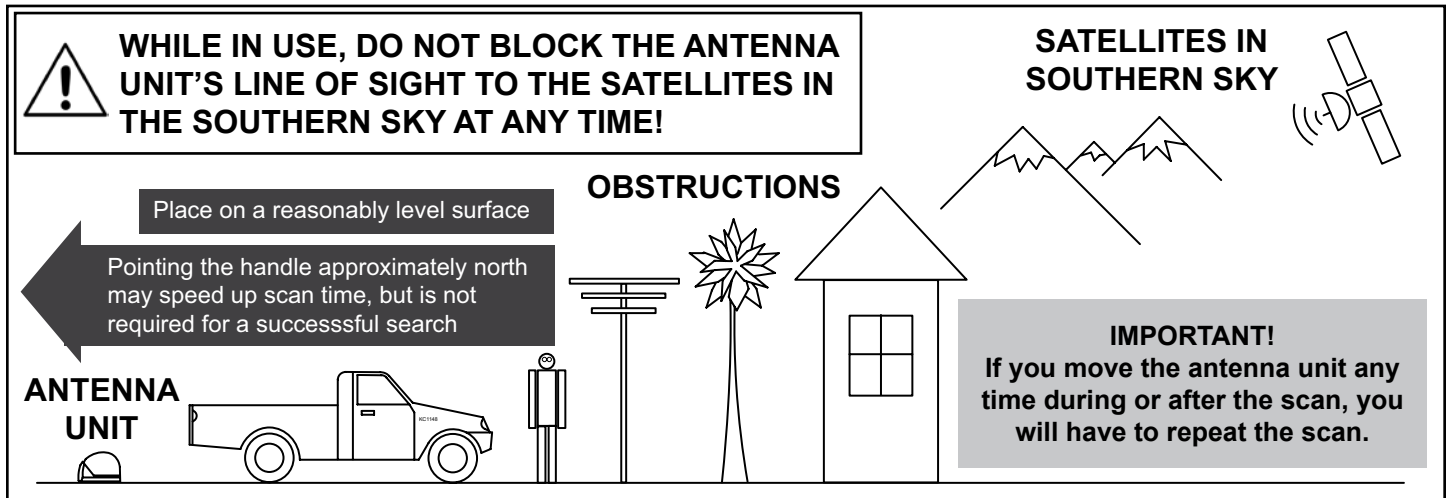

### RAIN AND SNOW FADE

Though rare, heavy rain, snow, or dense cloud cover can reduce the satellite signal, which may interrupt your programming. Your programming should return as conditions improve.

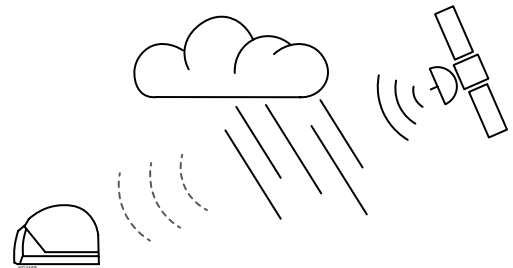

## SECURITY



The KING Antenna can be secured to an object by looping a cable thru the handle.

Cable sold separately.

# SETUP

## CONTENTS

Antenna Unit

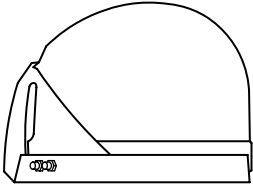

Power Inserter with Power Supply

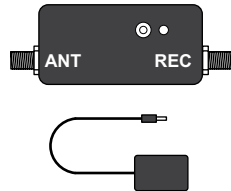

You will also need (sold separately):

DIRECTV  
Programming  
Subscription

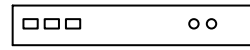
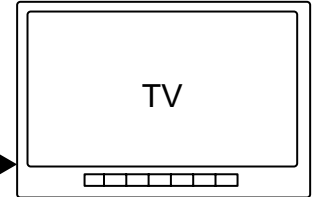

Cable(s)

DIRECTV Receiver

For the most up-to-date receiver compatibility information, go to [kingconnect.com/support](http://kingconnect.com/support)



Installation  
Guide



Quick  
Reference  
Guide



Registration  
Card

(3) Rubber  
Feet



50' RG-6  
Coax Cable

## APPLY RUBBER FEET TO ANTENNA UNIT

### IMPORTANT!

Do not apply rubber feet if roof-mounting the antenna unit.  
See the Installation Guide included in the box.

Do not  
apply here.

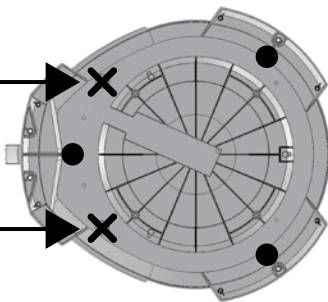

Apply (3)  
rubber feet

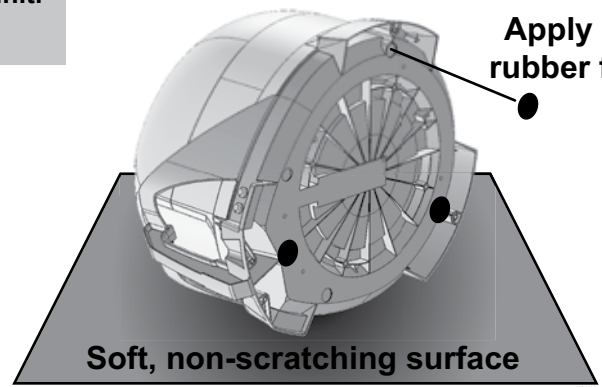

Soft, non-scratching surface

# CONNECTIONS

**NOTE:** If you wish to roof mount the antenna, see the Installation Guide that came with your KING One Pro.

**Make the connections on page 6 or page 7.**

**PAGE 6:** Make these connections unless you have an H/HR25 or higher receiver.

**PAGE 7:** Make these connections if you have an H/HR25 or higher receiver.  
(Requires DSWM30 Kit - sold separately)

**NOTE:** The KING One Pro will not receive channels broadcast from DIRECTV's Ka band satellites at 99° and 103°.

When using page 7 connection diagram, you will not receive programming from the 119 satellite.

## ••••• IMPORTANT POINTS! •••••

**Connect all coax cables first. Plug in power inserter and then receivers.  
Power inserter is for indoor use only.**



Place the power inserter in an accessible location.

Do not over-tighten the coax connections.

Do not put sharp bends or kinks in the cables.

Do not route the cables where they can be tripped on or run over by a vehicle.



**HAND-TIGHTEN COAX.  
OVER-TIGHTENING CAN  
DAMAGE CONNECTIONS.**

**AVOID SHARP BENDS WHEN ROUTING COAX!**

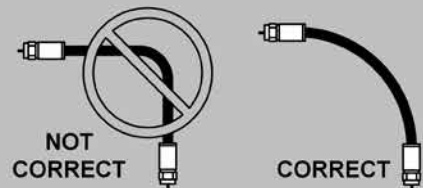

**After connecting and plugging in all components, wait for the power inserter LED to start flashing orange (about 10 seconds).**

**Go to page 8.**

# DIRECTV CONNECTIONS



**HAND-TIGHTEN COAX. OVER-TIGHTENING CAN DAMAGE CONNECTIONS.**

**AVOID SHARP BENDS WHEN ROUTING COAX!**

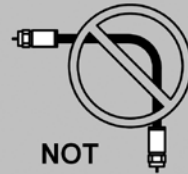

NOT CORRECT

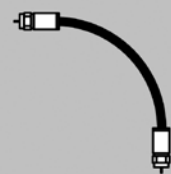

CORRECT

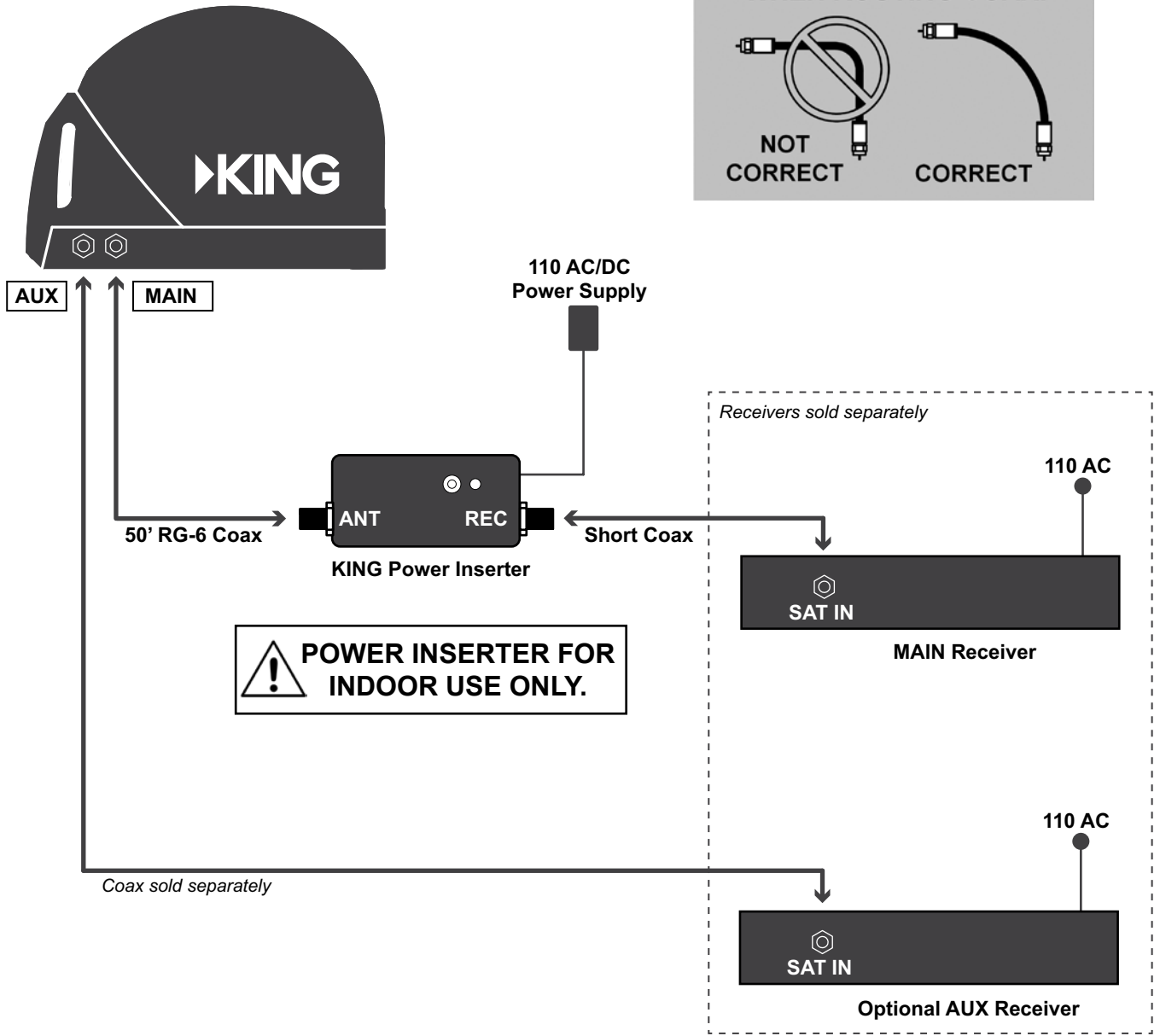

Second receiver must be configured the same as the main receiver (see operation section).

Second receiver must be the same as main receiver (SWM vs. non-SWM).

If your main receiver has a second "satellite in" port and built in DVR, you can connect this input to the AUX port to record programs on a different channel than the one you are watching.



# DIRECTV CONNECTIONS WITH H/HR25 RECEIVER OR HIGHER



**DO NOT** use DSWM30H or your receiver may be damaged.

DSWM30 is compatible with H21 or later receivers and HR20 or later DVRs. It is not compatible with D12 receivers.

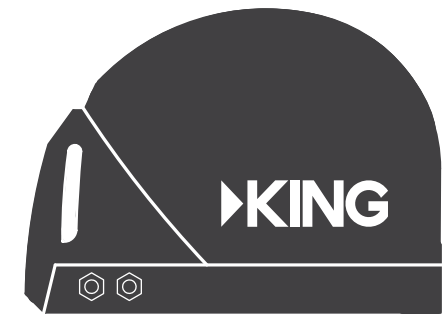
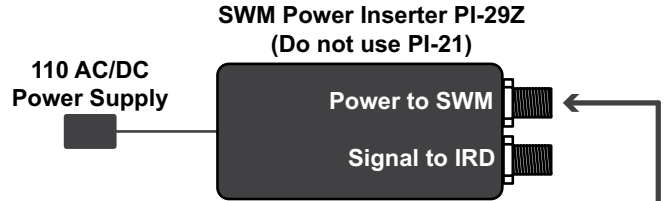

Not more than 100 ft of total RG-6 coax between antenna and DSWM30

For access to 101° satellite programming, connect the MAIN and AUX ports of the antenna to both LNB inputs labeled Sat 99°/101°

AUX MAIN

Not more than 50 ft of RG-6 coax between antenna and power inserter

**CONNECT COAX TO PROPER INPUTS!**  
MAIN TO 18V  
AUX TO 13V

110 AC/DC Power Supply

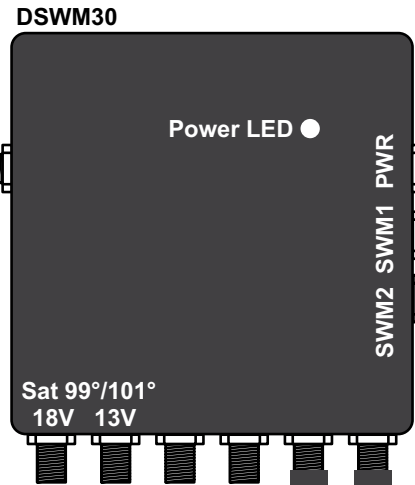

Unused SWM outputs: screw on dust cap (no center pin)

Not necessary if DSWM30 is used in dry conditions



**POWER INSERTER FOR INDOOR USE ONLY.**

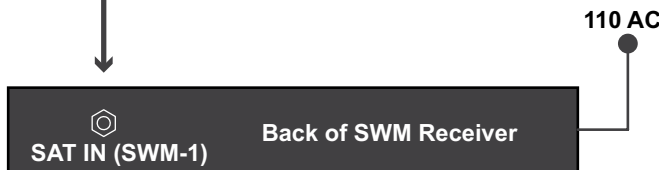

Receivers can be non-DVR or DVR receivers\*\*

\*\*If connecting to a DVR receiver, do not connect a coaxial cable to the Satellite 2 input. With SWM, only connect to the Satellite 1 port (labeled FTM or SWM)

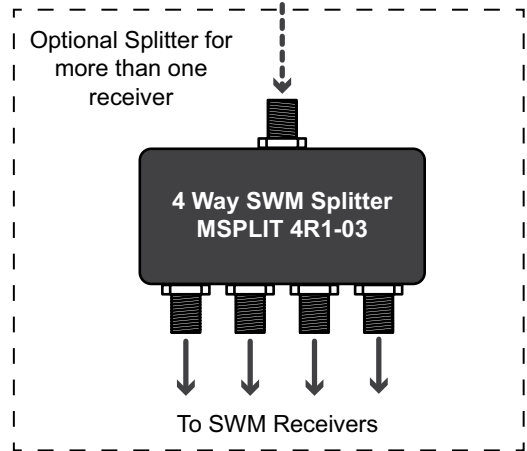

KING Antenna, KING Power Inserter (with power supply), 50' coax and short coax included. All other items sold separately.

# OPERATION

## RECEIVER CONFIGURATION

**Make sure your TV is on the correct input from your receiver.**

If your receiver screen does not appear on your TV, check TV input by pressing Source/Input button located on your TV or TV's remote.

**Configure your receiver as follows:**

**Switch Type:** Multi-switch

**Dish Type:** 3-LNB (18"x20") or 18x20" Triple-sat LNB

Make this one-time setting in the receiver's satellite setup menu.

## ANTENNA CONFIGURATION

DIRECTV uses mode 1. The KING One Pro comes factory preset for mode 1. If your antenna is new, you will not need to configure it.



**IF YOUR ANTENNA IS NEW, SKIP THIS STEP AND GO TO PAGE 10.**

MODE	SERVICE	SATELLITES	
1	DIRECTV	101, 119	DIRECTV subscribers
	DISH	61.5, 110, 119, 129	DISH subscribers with Wally, VIP211z, 211k, 211 or 411 receivers
2	DISH	110, 119, 129	DISH subscribers with receivers not listed in MODE 1
3	Bell TV	82, 91	Bell TV subscribers
4	DISH	61.5, 110, 119	DISH subscribers with receivers not listed in MODE 1



**IF YOUR ANTENNA IS NEW, SKIP THIS STEP AND GO TO PAGE 10.**

Make sure the LED is flashing orange (ready to scan)

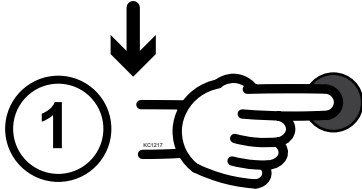

To enter Configuration Mode, press and hold (~3 sec) the power inserter button until one of the options below appears

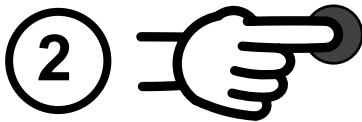

Press and release as needed to choose Mode 1

**MODE 1 (DIRECTV)**



**MODE 2**

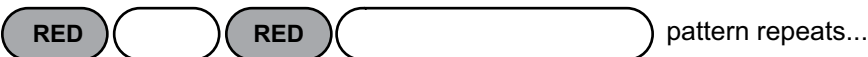

**MODE 3**



**MODE 4**



Press and hold (~3 sec) until LED flashes orange (ready to scan)



**Go to next page to start a scan.**

## SCAN FOR SATELLITES

Make sure the LED is flashing orange.



Press and release the power inserter button to start a scan



Antenna is scanning (flashing green)

SOLID GREEN

Both satellites found **Watch TV. Enjoy!**

**If one or both satellites were not found, you will get one of the flash patterns shown on the opposite page.**

Many times lack of satellite acquisition is due to obstructions. Try moving the antenna to have a better view of the southern sky, press the button once to turn the LED yellow, and a second time to start a new scan.

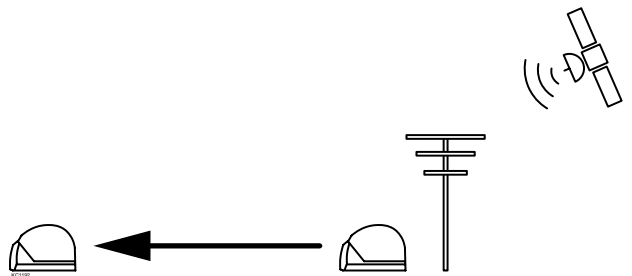

**NOTE:** If no satellites are found, you will have to start a new scan.

If only one satellite is found, you can press the button to turn the LED yellow and watch TV with limited channels.

If you get a different color and/or flash pattern on the LED than steady green or one of the patterns shown on the next page, the LED is flashing an error code. Call KING Customer Service for an explanation of the problem.

(952) 345-8147

# SATELLITES NOT FOUND

## MODE 1 (DIRECTV)

101 not found



119 not found



101 & 119 not found



# TROUBLESHOOTING

Symptom	Possible Cause	Troubleshooting
Antenna unit does not scan for satellites.	No power to antenna unit.	Make sure antenna unit is connected to power inserter.  Make sure power supply is plugged in and connected to power inserter.
Antenna unit scans but no picture on TV.	Improper connections made.	Make sure antenna unit is connected to power inserter, and power inserter is plugged in.  Make sure powered receiver is connected to TV and the power inserter.
Antenna unit scans but does not find satellite.	Line of sight obstruction.	Move antenna unit to have a clear view of the southern sky. Start a new scan.
Picture on TV goes in and out.	Temporary obstruction of signal.	Heavy rain or snow may cause loss of signal. Reception will improve as weather clears.  Make sure nothing is temporarily blocking view to the southern sky (like tree branches blowing in the wind).

If you connect or install the antenna unit using any of the vehicle's internal wiring/coax, and the antenna unit does not work properly, it could be the vehicle's wiring/coax. Connect a known good coax directly from the antenna unit to the power inserter and see if the problem goes away. If it does, the vehicle's wiring/coax is at fault. KING is not responsible for faulty vehicle wiring/coax.

# ACCESSORIES (Sold separately - see the satellite antenna accessories page at [kingconnect.com](http://kingconnect.com))

## MB700 Quick Release Roof-Mount Kit

Allows you to easily use your KING One Pro as either a roof-mounted or portable antenna.

KING Antenna not included.

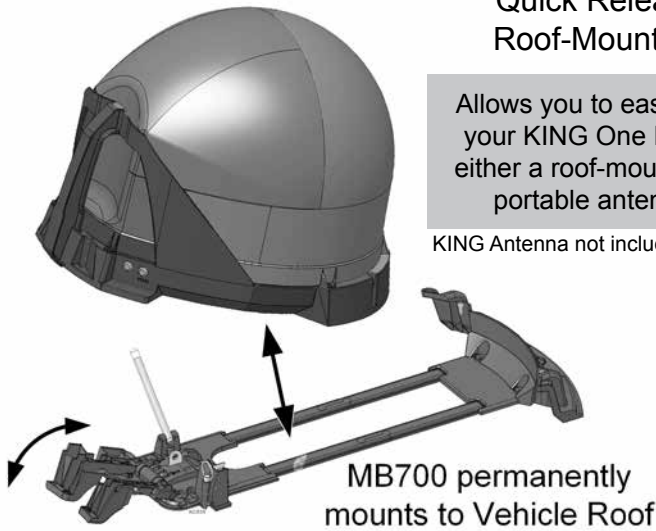

MB700 permanently mounts to Vehicle Roof

## MB500 Mounting Bracket

Includes (2)  
Hanger Brackets



Allows hanging of antenna unit on vehicle window or included hanger bracket.

For stationary use only.  
Vehicle must not be in motion while antenna unit is on window or hanger bracket.

KING Antenna not included.

## CB1000 Carry Bag

KING One Pro fits securely inside. Features include zippered cover, foam padding, carry handles and pockets for cables, receiver and remote.

KING Antenna not included.



## TR1000 Tripod Mount

Allows you to position your KING One Pro almost anywhere for best line of sight to satellite. Keeps antenna off the ground away from moisture.

KING Antenna not included.



## MB160 Mounting Bracket



MB160 Mounts to  
Back of Vehicle

The KING One Pro is not compatible with the MB100 Mounting Bracket. Use of the MB100 will void warranty.

The use of any unauthorized mounting bracket will void warranty.

KING Antenna not included.

# LIMITED WARRANTY

KING One Pro Satellite Antennas are thoroughly inspected and tested before leaving the factory, and are covered by the following limited warranty from the date of original purchase:

- Two-year parts warranty: The customer is not responsible for the cost of replacement parts if the original part is determined to be defective under the terms of the warranty. The customer is responsible for the cost of replacement parts after two years.
- One-year labor warranty: The customer is not responsible for labor costs to repair unit if labor is performed within the labor warranty period. The customer is responsible for all labor costs after one year.

Only KING and certified dealers may perform warranty evaluations and repairs. Depending upon the problem, KING may authorize a dealer to perform the necessary repairs. Any warranty labor outside of that performed at the factory is not covered unless 1) the product has been installed by an authorized dealer/installer or OEM manufacturer and 2) the dealer/installer receives prior authorization to perform the repair.

A certified dealer must not perform any repair without first contacting KING for a Service Order Number. KING will advise the dealer on how to proceed with any repairs.

Should any trouble develop during the warranty period, contact KING at (952) 345-8147. You must contact KING before the warranty period expires. The customer must supply proof of purchase (such as a dated sales receipt) when requesting warranty service. If the customer cannot supply proof of purchase, warranty period shall start 30 days after date of manufacture.

If it is determined that the unit needs to be returned to KING, customer must return COMPLETE product, freight prepaid, to:

**KING, 11200 Hampshire Avenue South, Bloomington, MN 55438-2453.**

If inspection shows the trouble is caused by defective workmanship or material, KING will repair (or at its option, replace) without charge.

When returning product, KING will supply an RMA number (Return Merchandise Authorization). This number must be clearly written on the box. Failure to clearly write RMA number on box may result in delays in processing claim. Along with product, customer should include in the box: his/her name, address, daytime phone number, proof of purchase and description of the problem.

This warranty does not cover installation and external wiring, or remanufactured units. This warranty does not cover damage caused by the use of an accessory other than a KING accessory designed for the product. This warranty is not transferable from the original owner.

Due to the expanding and changing TV market, KING cannot be held responsible for changes made to satellite services. Software updates to address such issues are not covered under warranty.

This warranty also does not apply where:

- The product has been abused, misused, improperly installed or improperly maintained.
- The product has been used with an accessory other than a KING accessory designed for the product.
- Repairs have been made or attempted by others that are not certified by KING to do such repairs.
- Repairs are required because of normal wear and tear.
- Alterations have been made to the product.
- The product or any associated component has been opened without authorization or disassembled to any degree.
- Damage has been caused by power washing.
- Circumstances beyond the control of KING cause the product to no longer operate correctly.
- Customer is not the original owner.

In no event shall KING be liable for any indirect, incidental, or consequential damages from the sale or use of the product. This disclaimer applies both during and after the term of this warranty. KING disclaims liability for any implied warranties, including implied warranties of "merchantability" and "fitness for a specific purpose," after the term of this warranty.

This warranty gives you specific legal rights, and you may also have other rights, which vary from state to state. Some states do not allow the exclusion or limitation of incidental or consequential damages, so the above limitation or exclusion may not apply to you. Some states do not allow limitations on how long an implied warranty lasts, so the above limitation may not apply to you.



# FCC GUIDELINES

This equipment has been tested and found to comply with the limits for a Class B digital device, pursuant to part 15 of the FCC Rules. These limits are designed to provide reasonable protection against harmful interference in a residential installation. This equipment generates, uses and can radiate radio frequency energy and, if not installed and used in accordance with the instructions, may cause harmful interference to radio communications. However, there is no guarantee that interference will not incur in a particular installation. If this equipment does cause harmful interference to radio or television reception, which can be determined by turning the equipment off and on, the user is encouraged to try to correct the interference by one or more of the following measures:

- Reorient or relocate the receiving antenna.
- Increase the separation between the equipment and the receiver.
- Connect the equipment into an outlet on a circuit different from that to which the receiver is connected.
- Consult the dealer or an experienced radio/TV technician for help.

## NOTES:



**Simply better, by design.™**

The logo features a grey right-pointing triangle to the left of the word "KING" in a bold, black, sans-serif font. A registered trademark symbol (®) is positioned at the top right of the letter "G".

---

---