

REV	DATE	DESCRIPTION
A	11/29/18	INITIAL RELEASE

THE INFORMATION CONTAINED IN THIS DRAWING IS THE SOLE PROPERTY OF ALTILIX LLC. ANY REPRODUCTION IN PART OR WHOLE WITHOUT THE WRITTEN PERMISSION OF ALTILIX LLC IS PROHIBITED. (C) 2018 ALTILIX LLC.

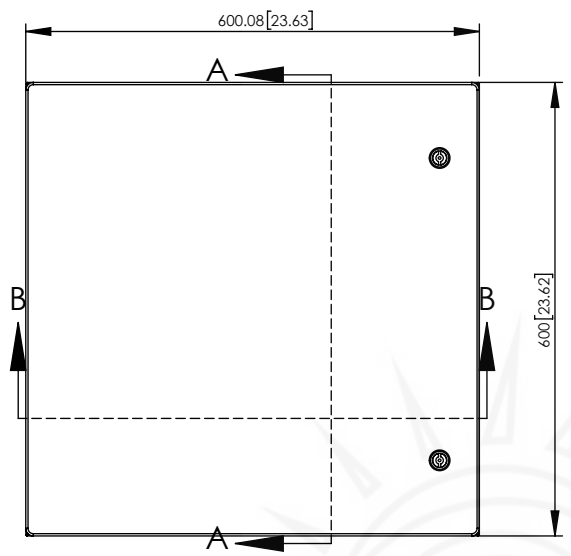

SECTION A-A

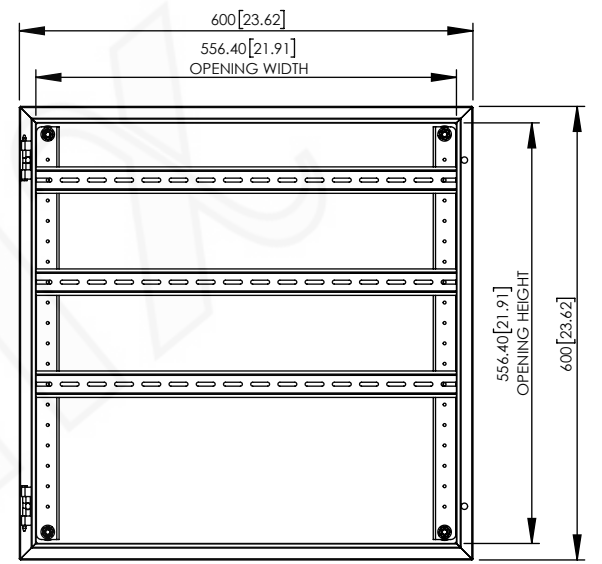
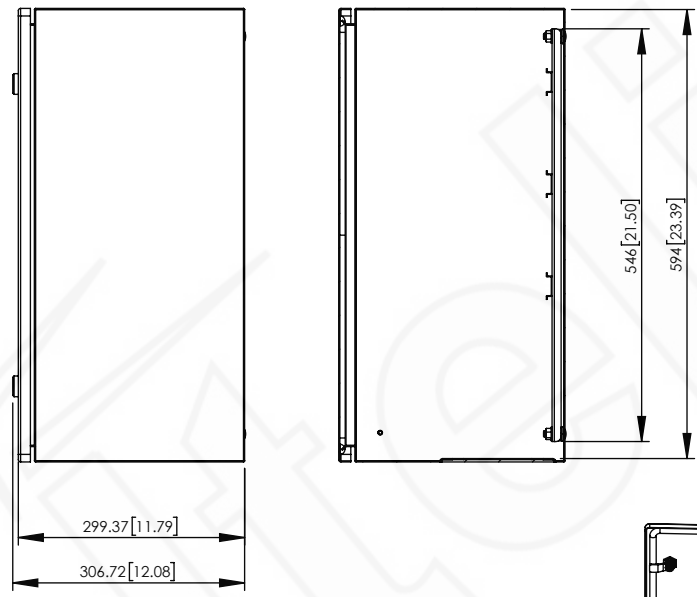

SECTION B-B

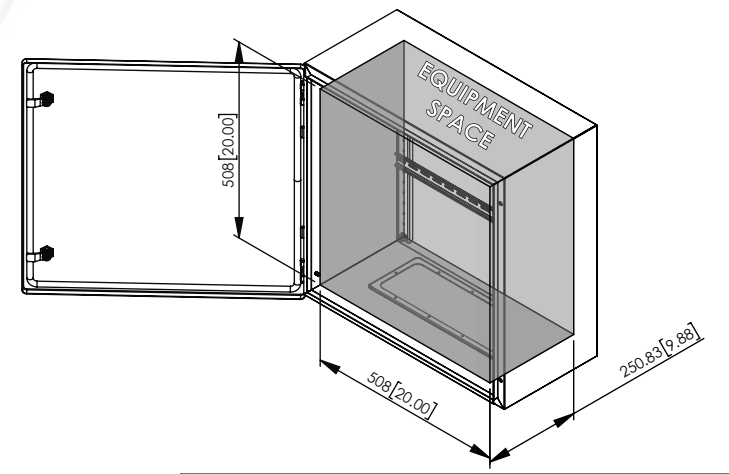
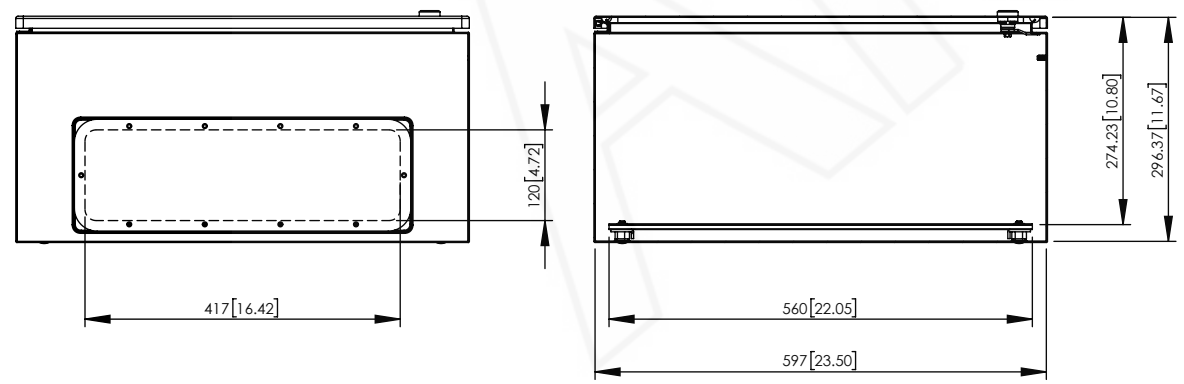

NO.	DESCRIPTION	MATERIAL	FINISH	QTY.
8	-	-	-	-
7	-	-	-	-
6	-	-	-	-
5	-	-	-	-
4	-	-	-	-
3	-	-	-	-
2	-	-	-	-
1	-	-	-	-

UNLESS OTHERWISE SPECIFIED:
 DIMENSIONS ARE IN MILLIMETERS.
 DIMENSIONS IN [] ARE IN INCHES AND
 ARE FOR CUSTOMER REFERENCE ONLY.

TOLERANCES FOR MILLIMETERS:
 0.5-8mm ± 0.20mm
 8-30mm ± 0.40mm
 30-120mm ± 0.50mm

TASK	NAME	DATE
DRAWN BY	N. COLUCCI	11/29/18
CHECKED	-	-
APPROVED	-	-

Altelix
 www.altelix.com

1201 Clint Moore Road
 Boca Raton, FL 33487
 TEL: 561-660-WIFI

PART DESCRIPTION
**24 X 24 X 12 PAINTED STEEL
 NEMA ENCLOSURE WITH DIN RAILS**

PART NUMBER: NS242412-DIN
 DRAWING NUMBER: DRW-NS242412-DIN
 SCALE: 1:10 REV: A SHEET 1 OF 1