



PUBLIC ADDRESS AMPLIFIER

PMM-60A

60 WATT RMS

PMM-120A

120 WATT RMS

	CAUTION RISK OF ELECTRIC SHOCK, DO NOT OPEN!	
	CAUTION: TO REDUCE THE RISK OF ELECTRIC SHOCK, DO NOT OPEN COVER. NO USER SERVICEABLE PARTS INSIDE. REFER SERVICING TO QUALIFIED SERVICE PERSONNEL.	

	WARNING: TO PREVENT FIRE OR SHOCK HAZARD, DO NOT EXPOSE UNITS NOT SPECIFICALLY DESIGNED FOR OUTDOOR USE TO RAIN OR MOISTURE.
---	--

	WARNING: REMOVAL OF THE COVER SHOULD ONLY BE PERFORMED BY QUALIFIED SERVICE PERSONNEL - NOT USER SERVICEABLE. THE UNIT SHOULD ALWAYS BE UNPLUGGED BEFORE REMOVING THE COVER, AND REMAIN UNPLUGGED WHILE THE COVER IS REMOVED.
---	---

PRECAUTIONS

1. Unpacking

After removing the amplifier from the carton, inspect for any exterior damage to the unit. If damage is noted, notify the carrier at once so that a claim can be justified. Save all packing material. This is important when the claim is processed.

2. Ventilation

To offset heat generated by the unit, it is necessary to provide ample ventilation around the unit. Avoid blocking or impeding the ventilation holes on the unit. To prevent unnecessary problems, install the unit in a place free from any vibrations, direct sunlight, humidity or dust circulation.

3. Avoid spilling liquids or allowing materials to enter the cabinet

If the unit gets wet or any foreign material enters the cabinet, immediately disconnect the A.C. line cord and consult your dealer or qualified technician.

IMPORTANT SAFETY INSTRUCTIONS

1. Read these instructions.
2. Keep these instructions.
3. Heed all warnings.
4. Follow all instructions.
5. Do not use this apparatus near water.
6. Clean only with dry cloth.
7. Do not block any ventilation openings. Install in accordance with the manufacturer's instructions.
8. Do not install near any heat sources such as radiators, heat registers, stoves, or other apparatus (including amplifiers) that produce heat.
9. Do not defeat the purpose of the polarized or grounding-type plug. A polarized plug has two blades with one wider than the other. A grounding type plug has two blades and a third grounding prong. The wide blade or the third prong are provided for your safety. If the provided plug does not fit into your outlet, consult an electrician for replacement of the obsolete outlet.
10. Protect the power cord from being walked on or pinched particularly at plugs, convenience receptacles, and the point where the exit from the apparatus.
11. Only use the attachments/accessories specified by the manufacturer.
12. Use only with the cart, stand, tripod, bracket, or table specified by the manufacturer, or sold with the apparatus. When a cart is used, use caution when moving the cart/apparatus combination to avoid injury from tip-over.
13. Unplug this apparatus during lightning storms or when unused for long periods of time.
14. Refer all servicing to qualified service personnel. Servicing is required when the apparatus has been damaged in any way such as power supply cord or plug is damaged, liquid has been spilled or objects have fallen into the apparatus, the apparatus has been exposed to rain or moisture, does not operate normally, or has been dropped.
15. Apparatus shall not be exposed to dripping or splashing and no objects filled with liquids, such as vases, shall be placed on the apparatus.
16. Warning – To reduce the risk of fire or electric shock, do not expose this apparatus to rain or moisture.
17. Apparatus shall not be exposed to dripping or splashing and no objects filled with liquids, such as vases, shall be placed on the apparatus.
18. Caution – Use of any controls or adjustments or performance of procedures other than those specified herein may result in hazardous radiation exposure.



Controls and Connections

FRONT PANEL

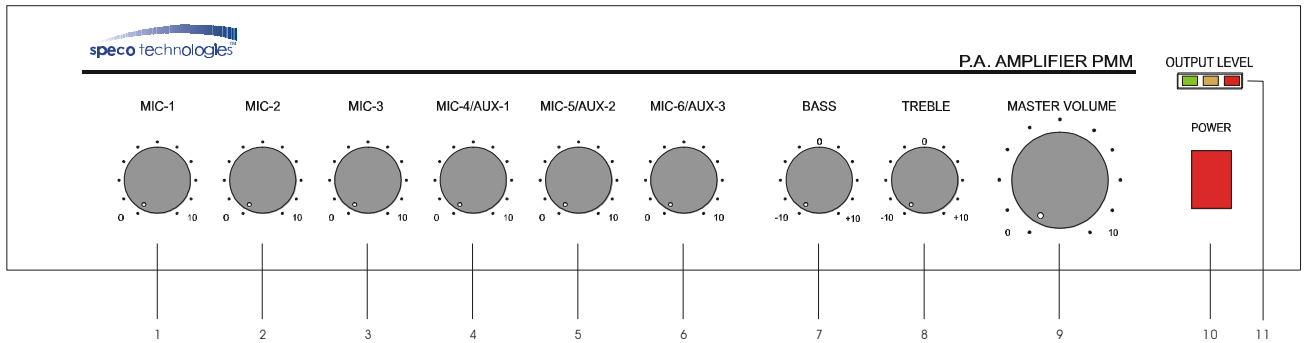

REAR PANEL

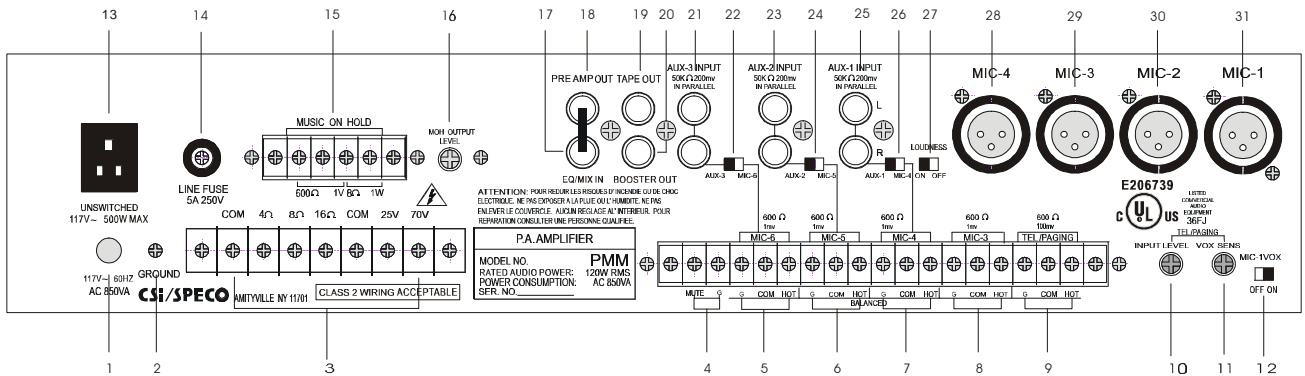

FRONT PANEL

- 1) MIC-1 Volume control
- 2) MIC-2 Volume control
- 3) MIC-3 Volume control
- 4) MIC-4/AUX-1 Volume control
- 5) MIC-5/AUX-2 Volume control
- 6) MIC-6/AUX-3 Volume control
- 7) Bass Control
- 8) Treble Control
- 9) Master Volume control
- 10) Power on/off switch with LED indicator
- 11) Output level indicator

REAR PANEL

- 1) AC power cord
- 2) Ground
- 3) Speaker outputs
- 4) Manual muting terminals
- 5) MIC-6 input terminals (Balanced)
- 6) MIC-5 input terminals (Balanced)
- 7) MIC-4 input terminals (Balanced)
- 8) MIC-3 input terminals (Balanced)
- 9) TEL/PAGING input terminals (Balanced)**
- 10) TEL/PAGING input level control
- 11) TEL/PAGING VOX sens. control
- 12) MIC-1 VOX on/off switch
- 13) AC accessory outlet (Unswitched)
- 14) AC fuse holder
- 15) MOH output terminals
- 16) MOH output level control*
- 17) EQ/MIX input RCA jack
- 18) Preamp output RCA jack
- 19) Tape output RCA jack
- 20) Booster output RCA jack
- 21) AUX-3 input RCA jacks
- 22) MIC-6/AUX-3 input selector switch
- 23) AUX-2 input RCA jacks
- 24) MIC-5/AUX-2 input selector switch
- 25) AUX-1 input RCA jacks
- 26) MIC-4/AUX-1 input selector switch
- 27) Loudness on/off switch
- 28) MIC-4 (XLR connector) input
- 29) MIC-3 (XLR connector) input
- 30) MIC-2 (XLR connector) input
- 31) MIC-1 (XLR connector) input

*MOH = Music on hold

**TEL/PAGING= Connection input terminals for general or emergency paging.

**TEL/PAGING is not to be connected directly to a telephone circuit or TNV circuit.

FRONT PANEL

- 1) **MIC-1 Volume control.** Adjusts audio level of MIC-1.
- 2) **MIC-2 Volume control.** Adjusts audio level of MIC-2.
- 3) **MIC-3 Volume control.** Adjusts audio level of MIC-3.
- 4) **MIC-4/AUX-1 Volume control.** Adjusts audio level of MIC-4/AUX-1.
- 5) **MIC-5/AUX-2 Volume control.** Adjusts audio level of MIC-5/AUX-2.
- 6) **MIC-6/AUX-3 Volume control.** Adjusts audio level of MIC-6/AUX-3.
- 7) **Bass Control.** Low frequency tone control.
- 8) **Treble Control.** High frequency tone control.
- 9) **Master Volume control.** Controls all volume levels simultaneously.
- 10) **Power on/off switch with LED indicator.** Illuminates when power is on.
- 11) **Output level indicator.** Indicates power output. Do not overload amp.

REAR PANEL

- 1) **AC power cord.** AC power cord with three pin plug for a 120VAC 50/60 Hz, power source. Do not defeat the ground pin.
- 2) **Ground.** Cabinet enclosure unit ground.
- 3) **Speaker outputs.** Speaker lines must be connected to "COM" and one (and only one) of the remaining screw terminals.
- 4) **Manual muting terminals.** Provides contact closure muting of the AUX-1~3 and MIC-2~6 input during paging.
- 5) **MIC-6 balanced input terminals.** Accepts a balanced low impedance microphone signal.
- 6) **MIC-5 balanced input terminals.** Accepts a balanced low impedance microphone signal.
- 7) **MIC-4 balanced input terminals.** Accepts a balanced low impedance microphone signal.
- 8) **MIC-3 balanced input terminals.** Accepts a balanced low impedance microphone signal.
- 9) **TEL / PAGING balanced input terminals.** Accepts a balanced telephone paging signal.
- 10) **TEL / PAGING input level control.** Controls audio level of telephone input.
- 11) **TEL / PAGING VOX sens. control.** Controls the sensitivity of VOX muting of TEL input.
- 12) **MIC-1 VOX on/off switch.** MIC-1 inputs include VOX muting switch of the MIC-2~6 and AUX-1~3 input during paging.
- 13) **AC accessory outlet (Unswitched).** Unswitched AC Auxiliary outlet for a 120VAC 50/60Hz power source.
- 14) **AC fuse holder.**
- 15) **MOH output terminals.** Provided two MOH outputs 600 Ohm, 1 Volt and 8 Ohm, 1 Watt.
- 16) **MOH output level control.** Controls volume of MOH output. (Music on hold)
- 17) and 18) **EQ / MIX input and preamp output RCA jacks.** Connects the mixer / preamplifier stage to the power amplifier stage. The connecting link must remain inserted for normal operation as a mixer / amplifier. If a sound compressor / limiter, equalizer, or an external signal processor is used in the sound system, connect the "PREAMP OUT" to the input of the external processor and the output of the processor to "EQ / MIX IN. The "PREAMP OUT" is after the tone controls and the master volume control.

STANDARD NORMAL OPERATION

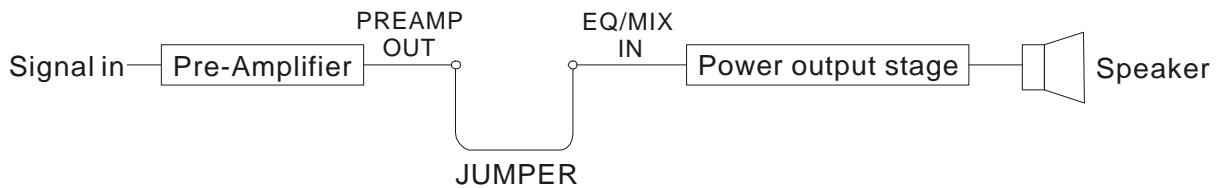

OPERATION WITH MIXER ,EQUALIZER SOUND COMPRESSOR / LIMITER ETC.

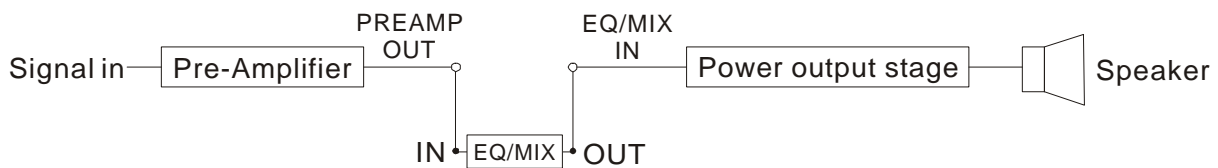

- 19) Tape output RCA jack.** An audio output to supply signal to a tape recorder. This signal is pre tone control and pre master volume control so that changing sound reinforcement level requirements do not affect the recording level.
- 20) Booster output RCA jack.** This output supplies the audio input signal to an additional “booster” or power amplifier. This signal is after tone control and master volume control. In this fashion, very large systems requiring more than 120 watts can be accommodated with an additional booster amp.
- 21) AUX-3 input RCA jacks** High impedance input available with parallel RCA jacks (for combining stereo output accessories).
- 22) MIC-6/AUX-3 input selector switch.** Allows for selection of either low impedance MIC-6 input or high impedance AUX-3 input.
- 23) AUX-2 input RCA jacks** High impedance input available with parallel RCA jacks (for combining stereo output accessories).
- 24) MIC-5/AUX-2 input selector switch.** Allows for selection of either low impedance MIC-5 input or high impedance AUX-2 input.
- 25) AUX-1 input RCA jacks** High impedance input available with parallel RCA jacks (for combining stereo output accessories).
- 26) MIC-4/AUX-1 input selector switch.** Allows for selection of either low impedance MIC-4 input or high impedance AUX-1 input.
- 27) Loudness on/off switch.** Loudness adjustment for AUX-1~3, +8dB @100 Hz,+4dB @10 KHz.
- 28) MIC-4 (XLR connector) input.** Accepts a balanced low impedance microphone signal with an XLR connector.

29) MIC-3 (XLR connector) input. Accepts a balanced low impedance microphone signal with an XLR connector.

30) MIC-2 (XLR connector) input. Accepts a balanced low impedance microphone signal with an XLR connector.

31) MIC-1 (XLR connector) input. Accepts a balanced low impedance microphone signal with an XLR connector.

Note: MOH output features an internal selector jumper (factory set on AUX-1) AUX-1~3 when background music is provided at the AUX inputs. MOH output function depends on the jumper location or locations that are selected, see illustration on page 8.

Screw terminal designations: G-GND, HOT-Signal positive, COM-Signal negative/common.

Overcoming Ground Loop Problems

If the amplifier is mounted in a rack unit (Use rack mount part # PBM-RK2), or is used with equipment having its own ground, it is necessary to ensure that ground loops and the associated problems of hum on the output signal are not introduced by the ground wiring. (see warning)

Warning

To overcome this problem if it occurs, the electrical and the mechanical ground on the amplifier may be separated by completely removing the wire connecting the power source to ground.

CONSULT AN ELECTRONICS TECHNICIAN TO ACCOMPLISH THIS TO AVOID POTENTIAL PERSONAL INJURY OR A HAZARDOUS CONDITION.

SPEAKER CONNECTION

The rear panel of the amplifier contains a 7 screw terminal strip for connection of speakers. BE CAREFUL TO CONNECT SPEAKERS PROPERLY, see impedance and line voltage instructions below.

The speaker lines are to be connected directly between the appropriate COM terminal on the 7 screw terminal strip and the terminal corresponding to the impedance of the speaker(s) or of the line voltage selected. (70V or 25V)

4, 8 and 16 OHM CONNECTIONS (refer to figure 3).

Connect the cables to the terminals on the 7 screw terminal strip provided. Use the screw terminals which correspond to the impedance of the speaker(s). One lead must always be connected to the COM. This is just an example. If in doubt consult a qualified technician.

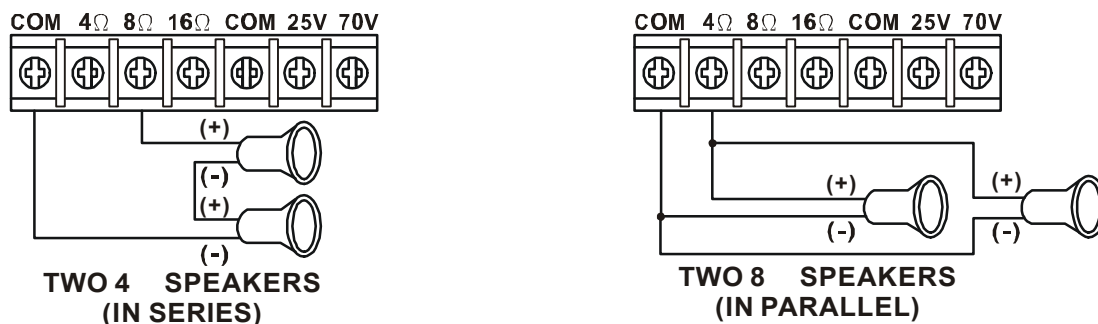

FIGURE 3

25V and 70V CONSTANT LINE VOLTAGE CONNECTIONS

(refer to figure 4).

IMPORTANT NOTICE: When the 25V and 70V constant line voltages are used, a line matching transformer must be used with each speaker. All transformers must be connected in parallel.

HOW TO CONNECT LINE MATCHING TRANSFORMERS IN PARALLEL

(25 VOLT LINE OR 70 VOLT LINE)

ALWAYS CONNECT LINE TRANSFORMERS IN PARALLEL

NEVER CONNECT LINE TRANSFORMERS IN SERIES

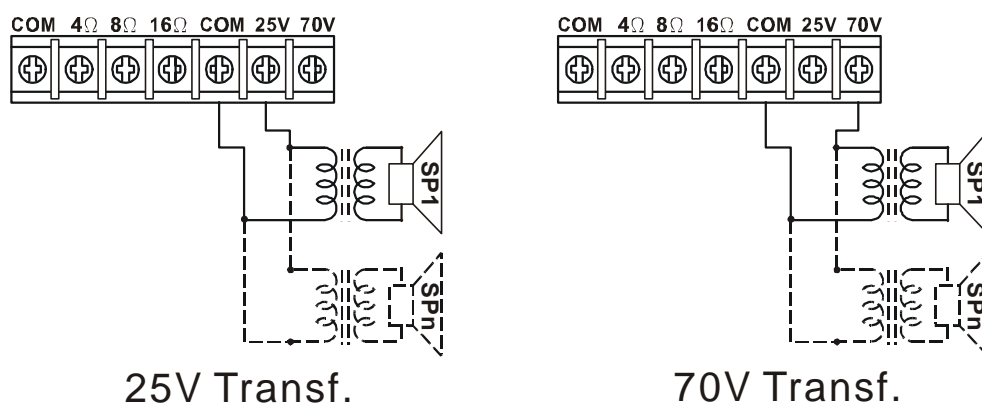

FIGURE 4

SPEAKER IMPEDANCES:

Speaker impedance taps for 4, 8 and 16 Ohm speakers are provided on a terminal strip on the rear panel of the unit. Also, outputs for 25V and 70V constant line voltage are provided. To connect the power output directly to a speaker or PA horn or a combination of speakers and/or PA horns which have a resulting voice coil impedance of 4,8 or 16 Ohm, connect to the COM and the proper impedance tap on the terminal strip. Be sure the speaker(s) or PA horn(s) is capable of handling a reasonable power output from the amplifier or permanent damage to the speaker(s) or PA horn(s) may result. Also, be careful not to overload the amplifier with too many speakers or PA horns. If it is desired to use a number and variety of speakers, the speakers must be arranged in various series or parallel arrays to provide proper impedance matching or the 25V or 70V constant line voltage must be used (parallel connection only). If you are not familiar with impedance matching, consult a professional installer or technician for advice. If the 25V or 70V constant line voltages are used, a line matching transformer must be used with each speaker. Again do not overload or use incompatible speakers. Line transformers are the preferred method for multi-speaker installation.

CABLE REQUIREMENTS

Output cabling need not be shielded in most cases and should be of sufficient gauge to minimize losses due to the resistance of the wire over long runs (insertion loss). Cable thinner than 18 gauge is not recommended. Long runs require 16 gauge or heavier.

In some cases, where the output cable is run in close proximity to unshielded intercom cables, electrical cables, radio transmission antennas or other sources of interference or when the amplifier is being used for paging from a telephone system, the amplifier may require shielded output cabling to prevent audio feedback or interference.

PRIORITY PAGE:THE AMPLIFIER FEATURES A VOICE ACTIVATED PRIORITY PAGE CIRCUIT AND AUTOMATICALLY MUTES ALL PROGRAM MATERIAL (TUNER/TAPE/CD,ETC.) FROM THE AMPLIFIERS OUTPUT AND PERMITS MICROPHONE # 1 AND THE TELEPHONE INPUT TO OVERRIDE FOR PAGING ANNOUNCEMENTS.

TELEPHONE LINE: A TELEPHONE LINE INPUT OF 600 OHM IS PROVIDED.

THERE ARE MANY OTHER FEATURES OFFERED. PLEASE READ MANUAL COMPLETELY.

WHENEVER IN DOUBT ABOUT INSTALLATION, CONSULT WITH A PROFESSIONAL INSTALLER OR TECHNICIAN OR PERSONAL INJURY, DAMAGE TO THIS AMPLIFIER AND/OR SPEAKERS MAY RESULT AND YOUR WARRANTY MAY BE VOIDED.

MUSIC ON HOLD AND PHANTOM POWER JUMPER POSITIONING

These adjustments are to be made by qualified technical personnel – Be certain unit is disconnected from A/C power source prior to removing unit' s cover or electrical shock or injury may result. The unit provides a Phantom Power DC 15V for electret condenser microphone use. Jumper location is to enable (ON) or disable (OFF) Phantom Power feature. Note: Units come with Phantom Power enable (ON).

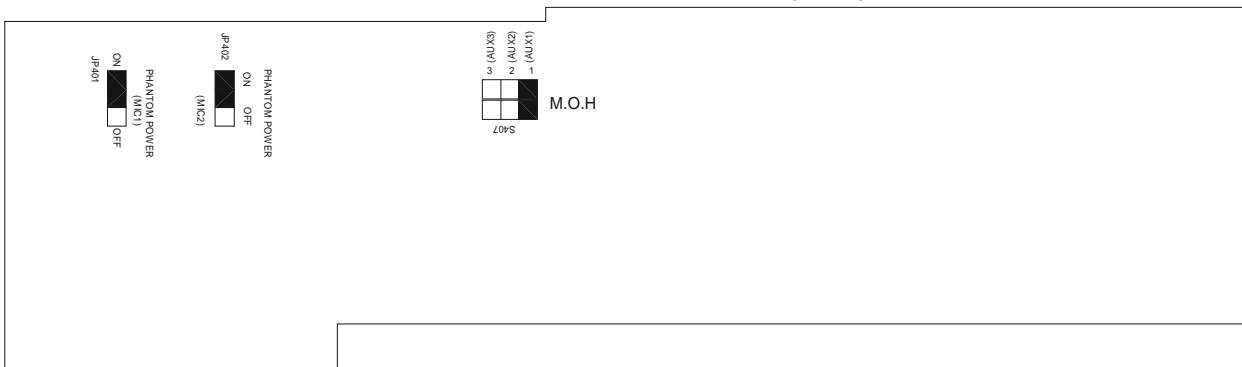

Jumper location to select AUX input for music on hold output.(MOH on above diagram)

Note: Units come with jumper set on AUX-1.



Determining Your Amplifier Needs for Sound Systems

- Step 1: Fill out Wattage Tap Requirement Chart (to right) determining the number of speakers that will be used at each wattage tap for the amplifier.
- Step 2: Multiply the number of speakers by each wattage tap to determine Total Wattage Requirement per Tap setting (See Ex A).
- Step 3: Add all the figures in shaded area to determine the total Wattage Requirement for the amplifier.
- Step 4: Match total Wattage Requirement to the bottom chart "Recommended Amplifier Wattage Chart" to determine acceptable RMS Wattage your amplifier should have.
- Step 5: Repeat this process for each amplifier system required.

Wattage Tap Requirement Chart

	Set Wattage Taps		Number of Speakers at Set Tap	=	Total Wattage Requirement per Tap Setting
Ex A)	5	X	10	=	50
	60	X	_____	=	_____
	30	X	_____	=	_____
	20	X	_____	=	_____
	15	X	_____	=	_____
	10	X	_____	=	_____
	7.5	X	_____	=	_____
	5	X	_____	=	_____
	4	X	_____	=	_____
	3.75	X	_____	=	_____
	2.5	X	_____	=	_____
	2	X	_____	=	_____
	1.50	X	_____	=	_____
	1.25	X	_____	=	_____
	1.00	X	_____	=	_____
	0.50	X	_____	=	_____
	0.25	X	_____	=	_____
	0.125	X	_____	=	_____
Total Sum of Shaded Area Represents Total Wattage Requirement					_____

Recommended Amplifier Wattage Chart

	Acceptable Amplifier RMS Wattage			
	15 Watt	30 Watt	60 Watt	120 Watt
If Sum Wattage Total is 12 Watts or Less	X	X	X	X
If Sum Wattage Total is between 13 and 24 Watts	X*	X	X	X
If Sum Wattage Total is between 25 and 48 Watts	X*	X*	X	X
If Sum Wattage Total is between 49 and 96 Watts	X*	X*	X*	X
If Sum Wattage Total is between 97 and 204 Watts	X*	X*	X*	X*
If Sum Wattage Total is between 205 and 216 Watts		X*	X*	X*
If Sum Wattage Total is between 217 and 240 Watts			X*	X*
If Sum Wattage Total is between 241 and 288 Watts				X*

* RMS Amplifier used in conjunction with Speco Technologies' P-240A Power Booster Amp

SPECIFICATIONS

Type	Public Address Mixer Power Amplifier	
Model No.	PMM-60A	PMM-120A
Power supply	AC 120V, 50/60Hz	AC 120V, 50/60Hz
Rated output power	60W RMS	120W RMS
Frequency response	50~15 KHz ± 3dB	50~15 KHz ± 3dB
Total harmonic distortion	1% or less at 1 KHz at rated output	1% or less at 1KHz at rated output
Input sensitivity and impedance	TEL :100mV/600 Ohm, Balanced MIC-1~6 : 1.0mV/600 Ohm, Balanced AUX-1~3 : 200mV/50K Ohm, Unbalanced EQ/MIX IN : 1V/50K Ohm, Unbalanced	TEL :100mV/600 Ohm, Balanced MIC-1~6 : 1.0mV/600 Ohm, Balanced AUX-1~3 : 200mV/50K Ohm, Unbalanced EQ/MIX IN : 1V/50K Ohm, Unbalanced
S/N Ratio	MIC-1~6 Better than 60 dB TEL Better than 60 dB AUX-1~3 Better than 70 dB	MIC-1~6 Better than 60 dB TEL Better than 60 dB AUX-1~3 Better than 70 dB
Speaker outputs	4 Ohm, 8 Ohm, 16 Ohm 25V, 70V line outputs	4 Ohm, 8 Ohm, 16 Ohm 25V, 70V line outputs
Output sensitivity and impedance	Tape out : 350mV/4.7K Ohm Pre out : 1V/600 Ohm Booster out : 1V/600 Ohm	Tape out : 350mV/4.7K Ohm Pre out : 1V/600 Ohm Booster out : 1V/600 Ohm
*MOH output	600 Ohm @ 1V and 8 Ohm - 1Watt	600 Ohm @ 1V and 8 Ohm - 1Watt
Mute level	AUX-1~3/MIC-2~6 40 dB	AUX-1~3/MIC-2~6 40 dB
VOX level	MIC-1/TEL 0~40 dB Adjustable	MIC-1/TEL 0~40 dB Adjustable**
Loudness control AUX-1~3	+8dB @100Hz,+4dB @10KHz	+8dB @100Hz,+4dB @10KHz
Phantom Power MIC-1~6	15 V DC	15 V DC
Tone control	Bass: ± 10 dB at 100Hz Treble: ± 10 dB at 10KHz	Bass: ± 10 dB at 100Hz Treble: ± 10 dB at 10KHz
Dimensions	430mm(W)x88mm(H)x300mm(D) 16.9" (W)x3.5" (H)x11.8" (D)	430mm(W)x88mm(H)x300mm(D) 16.9" (W)x3.5" (H)x11.8" (D)
Weight	Approx 18.7 lbs (8.5 kgs)	Approx 22 lbs (10.0 kgs)
Finish	Black	Black
Mounting options	Table top or 19" rack mountable (Use # PBM – RK2 rack mount bracket)	Table top or 19" rack mountable (Use # PBM – RK2 rack mount bracket)

*MOH = Music on hold **Factory set : -40dB

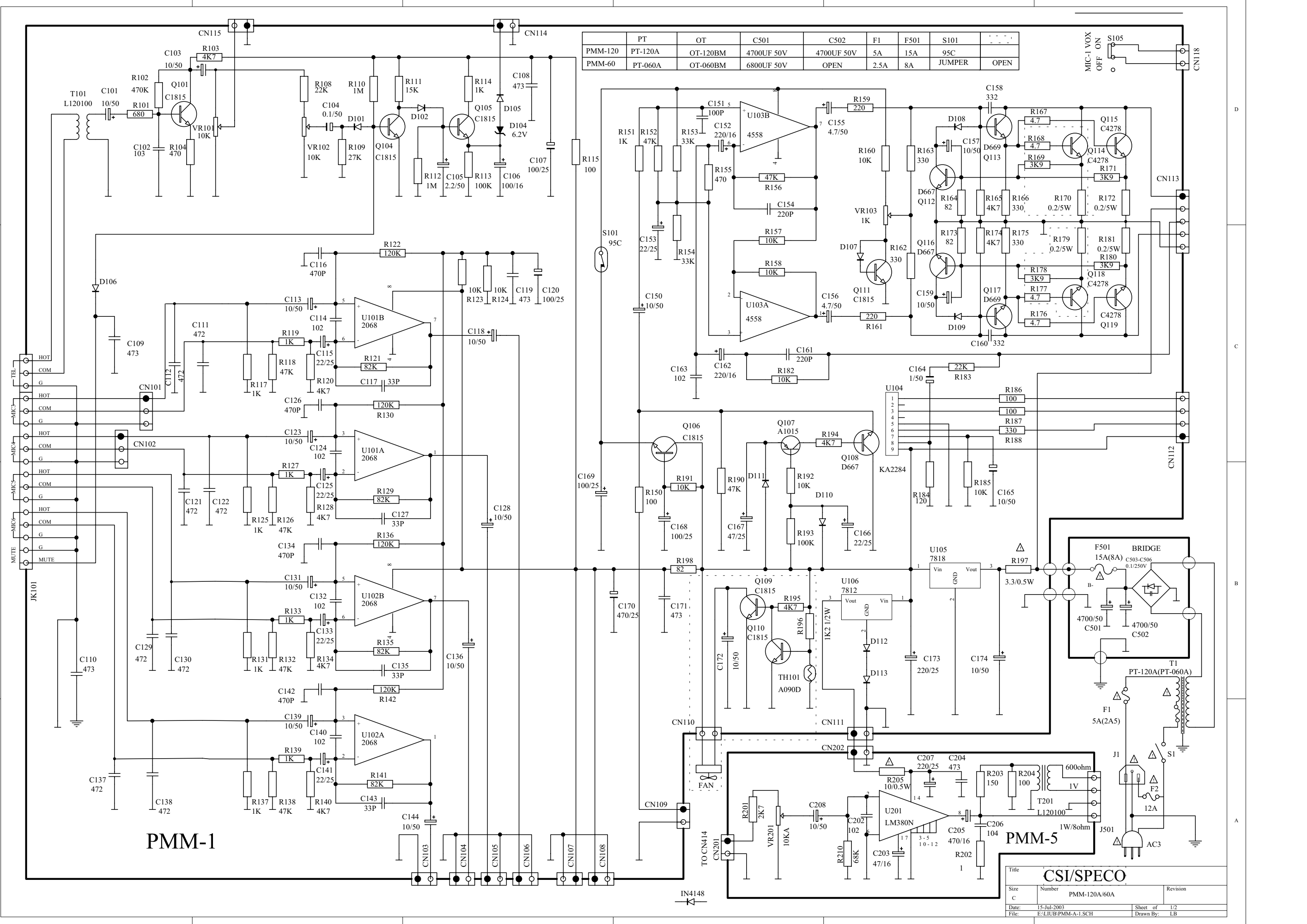

	PT	OT	C501	C502	F1	F501	S101	
PMM-120	PT-120A	OT-120BM	4700UF 50V	4700UF 50V	5A	15A	95C	
PMM-60	PT-060A	OT-060BM	6800UF 50V	OPEN	2.5A	8A	JUMPER	OPEN

PMM-1

PMM-5

Title CSI/SPECO		
Size C	Number PMM-120A/60A	Revision
Date: 15-Jul-2003	Sheet of 1/2	Drawn By: LB
File: E:\LUB\PMM-A-LSCH		

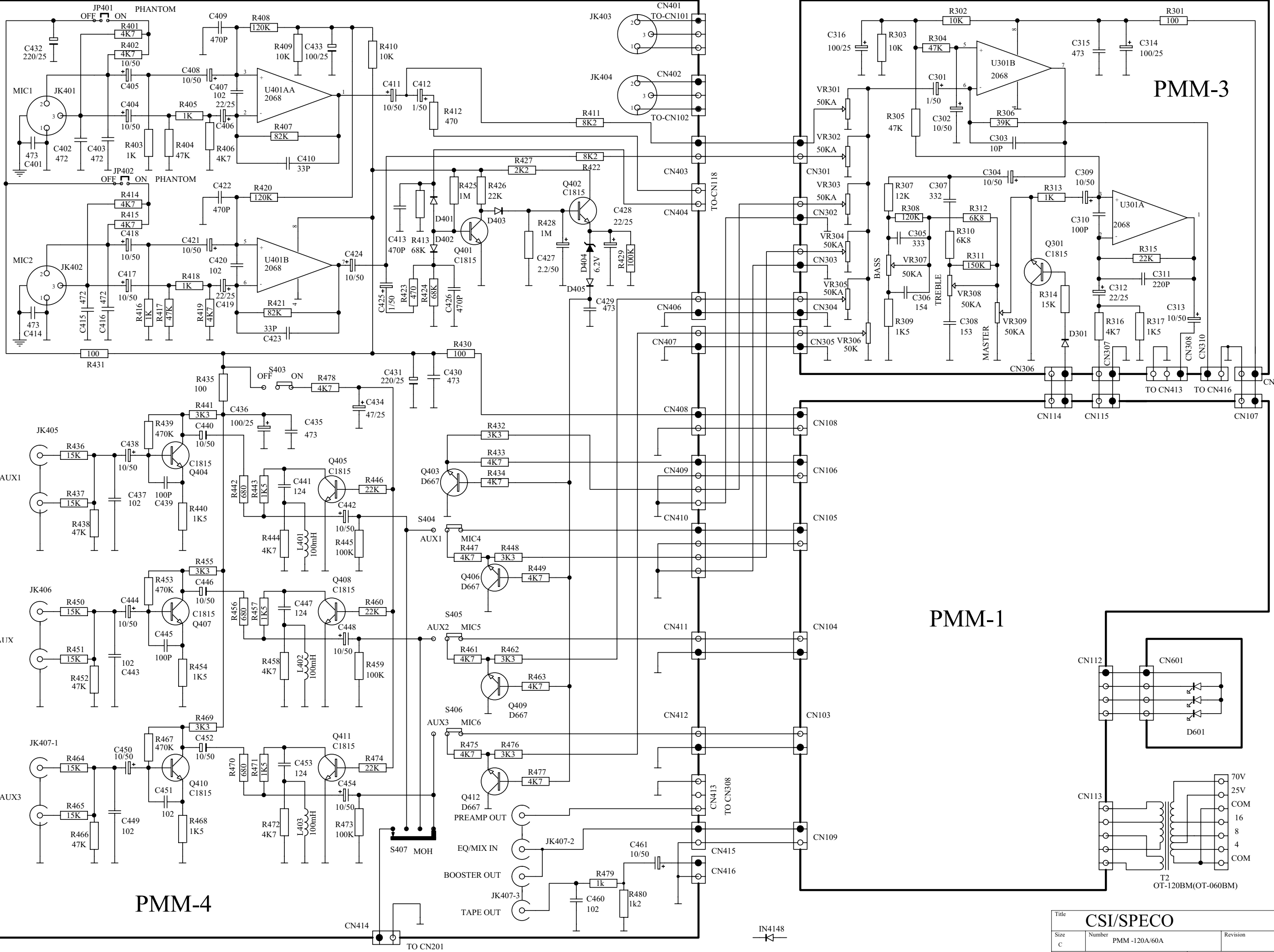

Title			
CSI/SPECO			
Size	Number	Revision	
C	PMM -120A/60A		
Date:	15-Jul-2003	Sheet of	2/2
File:	E:\LUB\PMM-B.SCH	Drawn By:	LB