



2.4/5 GHz 6 dBi Small Form Factor Outdoor Omni Antenna with 4x RPTNC Plug Connectors

Ventev's TerraWave Small Form Factor Outdoor Omni antenna provides outstanding RF coverage in a small, attractive package. The antenna is designed to operate with modern enterprise class 802.11n/ac MIMO access points, and each of its four dual-band leads support both 2.4 and 5 GHz signals. The antenna's reduced size and clean appearance, combined with excellent performance and durability, make it ideal for warehouse and manufacturing deployments. Includes an L-Bracket for mast and or wall mounting. *Every TerraWave antenna is covered by the company's two-year TerraNet warranty program. For questions and to purchase product, contact a regional sales executive at 210-375-8482, 800-851-4965 or sales@terrawave.com.*



Specifications	
Model	M6060060M1D43602M
Frequency Range	2400~2500 / 4900~5850 MHz
Bandwidth	100 / 985 MHz
Gain	6 dBi
Vertical Beamwidth	50°/30°
Horizontal Beamwidth	360°/360°
VSWR	≤2.0 / ≤2.0
Nominal Impedance	50 Ohms
Polarization	Vertical
Max Power Rating	10W
Dimensions	6" (H) x 4"(W)
Weight	3 lbs
Connector	4 x RPTNC Plug
Number/Length/Type Pigtails	4 x 3' Pigtails / RG58
Operating Temperature	- 40° F to +158° F

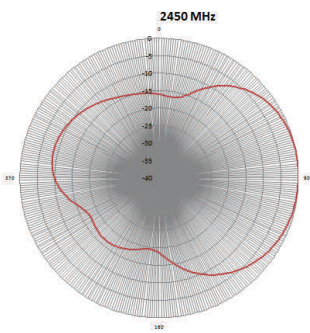

E-Plane Pattern

2.4 GHz

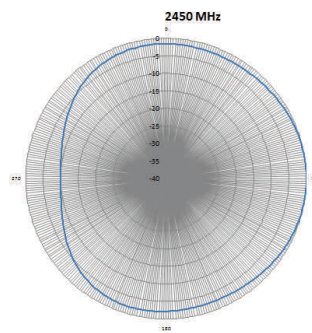

H-Plane Pattern

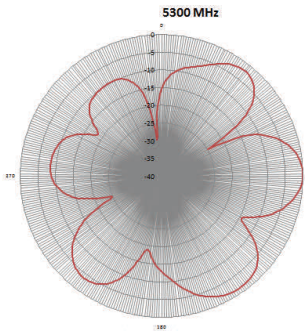

E-Plane Pattern

5 GHz

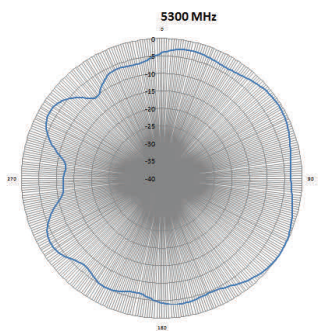

H-Plane Pattern

2.4/5 GHz 6 dBi Small Form Factor Outdoor Omni Antenna with 4x RPTNC Plug Connectors

Dimensions

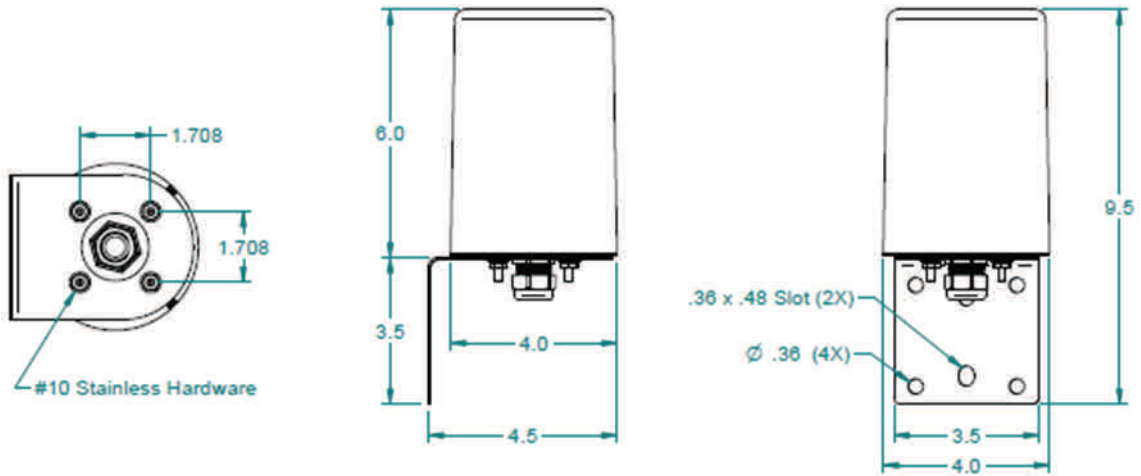

Mounting Information



Wall Mount

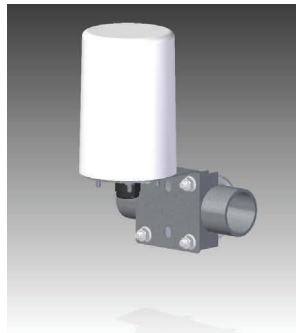

Horizontal Pipe Mount



Inverted Unistrut Vertical Mount



Vertical Pipe Mount

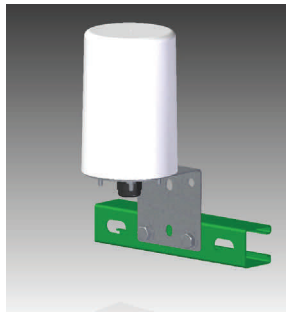

Unistrut Horizontal Pipe Mount

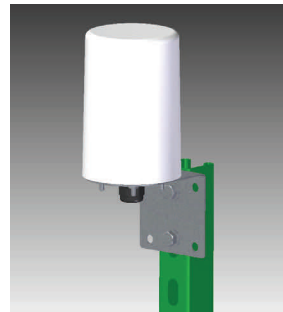

Unistrut Vertical Mount